



FTF-S1XG-B32Y-040D

SFP+ 10Gbps, BiDi, 1330/1270nm, single-mode, 40km



Description

FTF-S1XG-B32Y-040D series SFP+ transceiver can be used to setup a reliable, high speed serial data link over single-mode fiber. Maximum link span can reach 40km. This transceiver is based on WDM (BiDi) technology thus it is possible to send (TX:1330nm) and receive (RX:1270nm) data simultaneously in both directions over single strain of fiber. To establish working connection this transceiver should be matched with companion module (FTF-S1XG-B23Y-040D). Device is fully compliant with SFP+ MSA specifications and it is available in four hardware versions

Model	Operating case temperature
FTF-S1XG-B32Y-040D	0~70°C
FTF-S1XG-B32Y-040DI	-40~85°C

Host device can access module internal EEPROM memory and DDMI via I²C interface.

Built-in digital diagnostic interface (DOM, DDMI) allows a network administrator to monitor module parameters such as: transmitted and received optical power, temperature, supply voltage and laser current. Those information and data are very helpful e.g. in prediction and prevention of connection failures. A module is available in various dedicated versions, which can be compatible with devices from vendors such as Cisco, HP, Juniper, Extreme Networks, Alcatel-Lucent, 3Com, Linksys and more.

Applications

- 10G Ethernet
- Fiber Channel (10G FC)
- SONET/SDH (OC-192/STM64)



Key features

- LC Simplex receptacle
- Transmission distance up to 40km*
- DFB laser diode (1330nm) transmitter, PIN photodiode receiver (1270nm)
- Throughput up to 11.3Gb/s
- Fully compliant with SFP+ MSA INF-8431 and INF-8472 rev. 11.3
- Hot-Pluggable
- RoHS compliant
- Class 1 laser safety
- Low power dissipation (<1W)
- Metal case for low EMI
- Operating case temperature* : 0~70°C / -40~85°C

Specification

Supported transmission technology

10G Ethernet, Fibre Channel

Speed supported for Ethernet technology

10.25Gbps, 1.25Gbps

Speed supported for Fibre Channel technology

10.51875Gbps

Transmission medium

Single-mode fiber 9/125µm

Transmission distance**

40km

Receptacle type

LC Simplex

Wavelength

1330/1270nm

Output power

-1~+4dBm

Receiver sensitivity

-16dBm

Power supply voltage

3.3V

Total power consumption

< 1W

Operating environment – temperature*

0~70°C / -40~+85°C

Operating environment - humidity

5~95% non-condensing

Dimensions

Compliant with SFP+ Multi-Source Agreement

* - standard / industrial version

** - transmission distance depends on optical link attenuation



Detailed technical specification

Pin Description

Pin	Name	Function/Description	Engagement order	Notes
1	VeeT	Transmitter Ground	1	-
2	TX Fault	Transmitter Fault Indication	3	1
3	TX Disable	Transmitter Disable-Module disables on high or open	3	2
4	MOD-DEF2	Module Definition 2-Two wire serial ID interface	3	3
5	MOD-DEF1	Module Definition 1-Two wire serial ID interface	3	3
6	MOD-DEF0	Module Definition 0-Grounded in module	3	3
7	Rate Select	Not Connected	3	
8	LOS	Loss of Signal	3	4
9	VeeR	Receiver Ground	1	-
10	VeeR	Receiver Ground	1	-
11	VeeR	Receiver Ground	1	-
12	RD-	Inverse Received Data out	3	5
13	RD+	Received Data out	3	5
14	VeeR	Receiver Ground	1	-
15	VccR	Receiver Power - +3.3V±5%	2	6
16	VccT	Transmitter Power - +3.3 V±5%	2	6
17	VeeT	Transmitter Ground	1	-
18	TD+	Transmitter Data In	3	7
19	TD-	Inverse Transmitter Data In	3	7
20	VeeT	Transmitter Ground	1	-

Notes:

- TX Fault is open collector/drain output which should be pulled up externally with a 4.7KΩ-10KΩ resistor on the host board. When high, this output indicates a laser fault of some kind. Low indicates normal operation.
- TX Disable input is used to shut down the laser output per the state table below. It is pulled up to Vcc within the module.
Low (0 – 0.8V): Transmitter on
Open or High (2.0 – VccT): Transmitter Disabled
- Mod-Def 0, 1, 2. These are the module definition pins. They should be pulled up to Vcc with a 4.7KΩ-10KΩ resistor on the host board
Mod-Def 0 is grounded by the module to indicate that the module is present.
Mod-Def 1 is clock line of two wire serial interface for optional serial ID.
Mod-Def 2 is data line of two wire serial interface for optional serial ID.
- LOS (Loss of signal) - when high, this output indicates the received optical power is below the worst case receiver sensitivity (as defined by the standard in use). Low indicates normal operation.
- These are the differential receiver outputs. They are AC coupled 100Ω differential lines which should be terminated with 100Ω differential at the user SERDES. The AC coupling is done inside the module and thus not required on the host board.
- VccR and VccT are the receiver and transmitter power supplies. They are defined as 3.3V±5% at the SFP connector pin. The in-rush current will typically be no more than 30mA above steady state supply current after 500ns.
- TD-/+: These are the differential transmitter inputs. They are AC coupled differential lines with 100Ω differential termination inside the module. The AC coupling is done inside the module and is thus not required on host board.



Electrical parameters

Parameter	Symbol	Min.	Typ.	Max.	Unit	Notes
Transmitter Differential Input Volt	+/-TX_DAT	180		700	mV p-p	1
Receiver Differential Output Volt	+/-RX_DAT	180		850	mV p-p	2
Tx_Disable Input Voltage – Low	V _{IL}	0		0.8	V	
Tx_Disable Input Voltage – High	V _{IH}	2.0		V _{CC}	V	
Tx_Fault Output Voltage – Low	V _{OL}	0		0.8	V	3
Tx_Fault Output Voltage – High	V _{OH}	2.0		V _{CC}	V	3
Rx_LOS Output Voltage- Low	V _{OL}	0		0.8	V	3
Rx_LOS Output Voltage- High	V _{OH}	2.0		V _{CC}	V	3
Throughput	B			11.3	Gb/s	
Total current requirement				450	mA	

Transmitter parameters

Parameter	Symbol	Min.	Typ.	Max.	Unit	Notes
Central wavelength	λ_c	1320	1330	1340	nm	
Spectral width	$\Delta\lambda$			1	nm	
Launch optical power	P _o	-1		+4	dBm	4
Extinction ratio	EX	3.5			dB	
Dispersion penalty				3.2	dB	
Optical Return Loss Tolerance	ORLT	12			dB	
Optical rise/fall time	T _{rise} /T _{fall}			30	ps	5
Eye diagram	Compliant with IEEE802.3-2005 10Gbps					

Receiver parameters

Parameter	Symbol	Min.	Typ.	Max.	Unit	Notes
Sensitivity	P _{min}			-16	dBm	6
Stressed Sensitivity (OMA)				-14	dBm	
Central wavelength	λ_c	1260		1280	nm	
Receiver overload	P _{MAX}	0			dBm	6
RX_LOS Asserted	S _A	-30			dBm	
RX_LOS De-Asserted	S _D			-17	dBm	
RX_LOS Hysteresis	-		3.0		dB	

Notes:

1. Internally AC coupled and terminated to 100Ω differential load.
2. Internally AC coupled, but requires a 100Ω differential termination or internal to Serializer/Deserializer.
3. It is open collector/drain output which should be pulled up externally to V_{CC} with a 4.7KΩ-10KΩ resistor on the host board. LOS: logic 0 indicates normal operation; logic 1 indicates no signal detected.
4. Optical power is launched into SMF
5. 20-80%
6. Measured with PRBS 2³¹-1 at test pattern @10.3125Gbps.

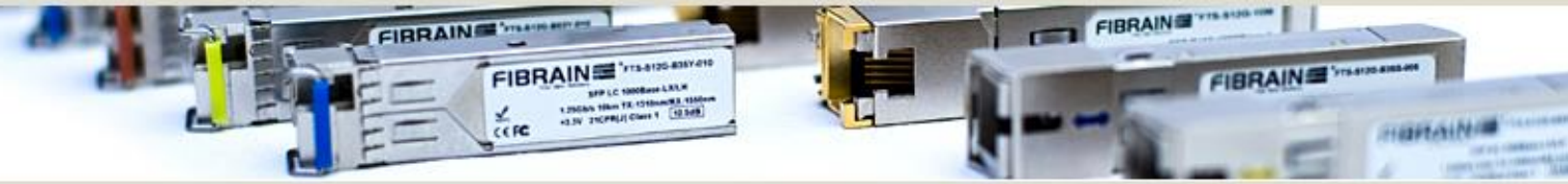

Mechanical specification

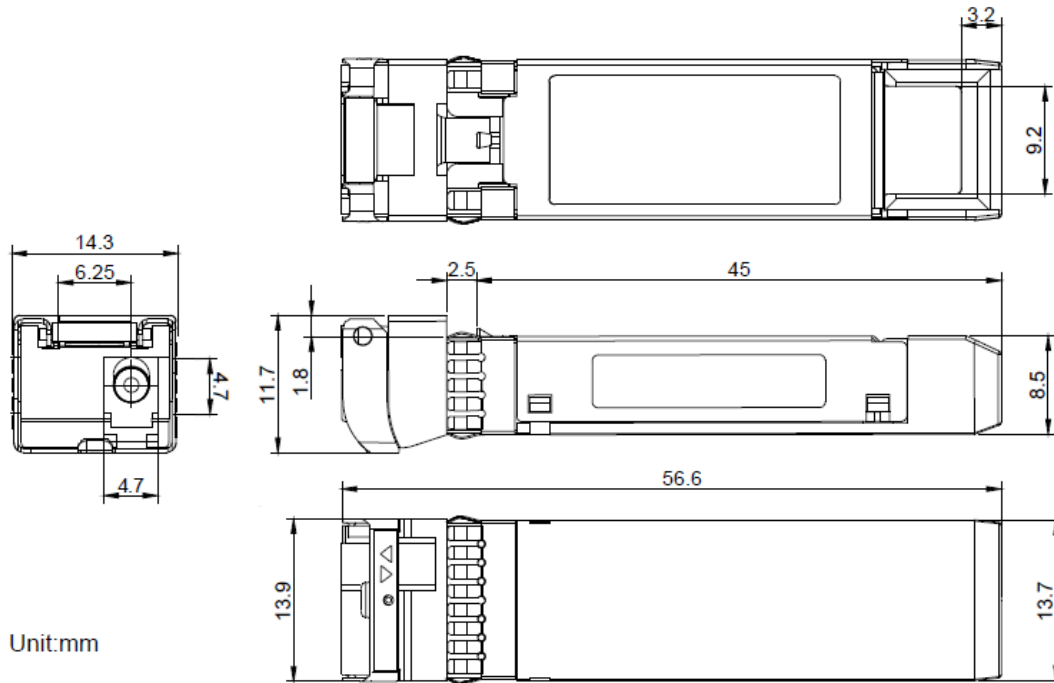

Recommended environment conditions

Parameter	Symbol	Min	Typ	Max	Unit
Operating Temperature Range (industrial)	T	-40	-	85	°C
Operating Temperature Range (standard)	T	0	25	70	°C
Supply Voltage	V _{CC}	3.135	3.3	3.465	V
Relative Humidity	RH	5	-	95	%

Ordering information

FTF-S1XG-B32Y-040**D** – 1330/1270nm, 40km, single-mode, LC simplex, **DDMI**, commercial temperature (0~70°C)

FTF-S1XG-B32Y-040**DI** – 1330/1270nm, 40km, single-mode, LC simplex, **DDMI**, **extended temperature** (-40~85°C)

For further information regarding host device PCB layout recommendation, power supply requirements, EEPROM memory map, DDMI specification please check:

[SFF-8472 - Description of EEPROM and Digital Diagnostic Monitoring Interface](#) and [SFF-8431 - Technical specification for SFP+ transceiver](#)

Fibrain Sp. z o.o. reserves the right to make changes to the products or information contained herein without notice. No liability is assumed as a result of their use or application.

Pictures used for reference only, actual product look may differ. For most actual information please contact technical support via aktywa@fibrain.pl